

Chapter 2

Electrical Protection for Power Systems

The Need for Electrical Protection

It is not economically feasible to design and manufacture electrical equipment that will never fail in service. Equipment will and does fail, and the only way to limit further damage to equipment, and to restrict danger to human life, is to provide fast, reliable electrical protection. The protection of a power system detects abnormal conditions, localizes faults, and promptly removes the faulty equipment from service.

Protective Relays

A PROTECTIVE RELAY is the device, which operates to disconnect a faulty part of the system, thereby protecting the remainder of the system from further damage. In fact, power protection has the following five main functions as its levels of discipline and functionality, shown in order of priority.

- To ensure safety of personnel
- To safeguard the entire system
- To ensure continuity of supply
- To minimize damage
- To reduce resultant repair costs

All of these requirements make it necessary to ensure early detection, localization, and rapid isolation of electrical faults and additionally prompt and safe removal from service of faulty equipment.

The Basic Requirements of Protection

In order to satisfy the above requirements, protection must therefore have the following qualities:

RELIABILITY :

To operate in the pre-determined manner when an electrical fault is detected.

SELECTIVITY / DISCRIMINATION:

To detect and safely isolate only the faulty item(s).

STABILITY / SECURITY:

To leave all healthy circuits intact and undisturbed and to ensure continuity of supply.

SENSITIVITY:

To detect even the smallest values of fault current or system abnormalities and operate correctly at its pre-set settings.

SPEED:

To operate speedily when it is required thereby minimizing damage and ensuring safety to personnel.

Electrical Faults

Electrical faults usually occur due to breakdown of the insulating media between live conductors or between a live conductor and earth. This breakdown may be caused by any one or more of several factors, e.g. mechanical damage, overheating, voltage surges (caused by lightning or switching), ingress of a conducting medium, ionization of air, deterioration of the insulating media due to an unfriendly environment or old age, or misuse of equipment.

Fault currents release an enormous amount of thermal energy, and if not cleared quickly, may cause fire hazards, extensive damage to equipment and risk to human life.

Switchgear needs to be rated to withstand and break the worst possible fault current, which is a solid three-phase short-circuit close to the switchgear. ('Solid' meaning that there is no arc resistance. Normally arc resistance will be present, but this value is unpredictable, as it will depend on where exactly the fault occurs, the actual arcing distance, the properties of the insulating medium at that exact instance, which will be changing all the time due to the heating effect of the arc, etc. Therefore, in fault calculations, the arc resistance is ignored, as it is undeterminable, with the result that the worst case is calculated. The arc resistance will tend to decrease the fault current.

Transient & Permanent Faults

Transient faults are faults that do not damage the insulation permanently and as such allow the circuit to be safely re-energized after a short period of time.

A typical example would be an insulator flashover following a lightning strike, which would be successfully cleared on opening of the circuit breaker, which could then be automatically reclosed.

Transient faults occur mainly on outdoor equipment where air is the main insulating medium.

Permanent faults, as the name implies, are the result of permanent damage to the insulation of either the transmission medium or the associated equipment attached to it.

Calculation of Short Circuit Currents

Accurate fault current calculations are normally carried out using an analysis method called "Symmetrical Components." This method involves the use of higher mathematics and is based on the principal that any unbalanced set of vectors can be represented by a set of 3 balanced systems, namely; positive, negative and zero sequence vectors.

However, for general practical purposes it is possible to achieve a good approximation of 3 phase short circuit currents using some very simple methods, which are discussed below.

The short circuit current at the secondary side and close to the transformer, can be quickly calculated by using the following formula:

$$\text{short-circuit MVA} = \frac{100P}{X\%}$$

$$\text{and Short - circuit current } I_{kA} = \frac{\text{MVA}}{\sqrt{3} \times \text{kV}}$$

where

P = Transformer rating in MVA

X% = Internal Reactance of Transformer in %

I_{kA} = Short-circuit current in kA

kV = Transformer secondary voltage in kV

TYPICAL % reactance values for transformers (X%) are shown in the table below.

Primary Voltage Reactance % at MVA rating					
MVA Rating	Up to 13.8kV	25kV	36kV	69kV	138kV
0.25	3.5	4.0	4.5	5.0	6.5
0.5	4.0	4.5	5.0	5.5	6.5
1.0	5.0	5.5	5.5	6.0	7.0
2.0	5.5	6.0	6.0	6.5	7.5
3.0	6.5	6.5	6.5	7.0	8.0
5.0	7.5	7.5	7.5	8.0	8.0
>=10	10.0	10.0	10.0	10.0	10.0

Table 2.1
Reactance Values

Normally, the % reactance value of the transformer can be obtained from the nameplate, or if not, from the transformer data sheets.

If a length of cable (more than 100m) exist between the transformer and the fault, the impedance of the cable has to be taken into account to arrive at a realistic value for the worst-case fault current. This is done by calculating the source impedance and then adding the cable impedance, as follows:

$$\text{Source Impedance} \quad Z = \frac{\text{kV}}{\sqrt{3} \times \text{kA}}$$

$$\text{Fault Current kA} = \frac{\text{kV}}{(Z_{\text{source}} + Z_{\text{cable}})}$$

Z_{cable} can be obtained from the manufacturer's cable data sheets.

The above calculation is another approximation, as Z_{source} and Z_{cable} are not necessarily in phase, and complex algebra should be used. However, it is accurate enough for most practical applications.

Fuses

Probably the oldest, simplest, cheapest and most-often used type of protection device is the fuse. The operation of a fuse is very straightforward: The thermal energy of the excessive current causes the fuse-element to melt and the current

path is interrupted. Technological developments have served to make fuses more predictable, faster and safer (not to explode).

A common misconception about a fuse, is that it will blow as soon as the current exceeds its rated value (i.e. the value stamped on the cartridge). This is far from the truth. A fuse has a typical inverse time-current characteristic, much the same as an IDMT relay. The pick-up value only starts at approximately twice the rated value, and the higher the current, the faster the fuse will blow.

By nature, fuses can only detect faults associated with excess current. Therefore, a fuse will only blow in earth fault conditions once the current in the faulty phase has increased beyond the overcurrent value. Therefore, fuses do not offer adequate earth fault protection. A fuse has only a single time-current characteristic, and cannot be adjusted. In addition, fuses need to be replaced after every operation. Finally, fuses cannot be given an external command to trip.

Fuses are very inexpensive. Therefore, they are suitable to use on less critical circuits and as back-up protection should the main protection fail, offering very reliable current-limiting features by nature.

Another advantage of fuses is the fact that they can operate totally independently, i.e. they do not need a relay with instrument transformers to tell them when to blow. This makes them especially suitable in applications like remote Ring Main Units, etc.

The Relay - Circuit-Breaker Combination

The most versatile and sophisticated type of protection available today, is undoubtedly the relay - circuit-breaker combination. The relay receives information regarding the network mainly from the instrument transformers (voltage and current transformers), detects an abnormal condition by comparing this information to pre-set values, and gives a tripping command to the circuit-breaker when such an abnormal condition has been detected. The relay may also be operated by an external tripping signal, either from other instruments, from a SCADA master, or by human intervention.

The most reliable way to provide auxiliary power to the relay is by way of a Battery Tripping Unit (BTU). The unit basically consists of a set of batteries which supplies DC power to the relay and trip circuit. The batteries are kept under

charge by a battery charger, which normally is rated to have enough capacity to supply the standing load of the switchgear panel (relay auxiliary power, indication lamps, etc.). When a temporary high current is needed, usually to provide a circuit-breaker tripping supply, the batteries will supply this, and be recharged after the event. The batteries then also function as a full back up in case of total power failure.

The AC input to the BTU is usually supplied from the panel VT, or from a lighting transformer.

What often occurs in practice, and which is very bad engineering practice, is to power the relay and trip circuit directly from the panel VT. This will function correctly in most instances, but when a really severe three-phase short-circuit occurs, the voltage of the substation may drop quite dramatically, causing malfunction of the tripping circuit.

There are other ways to overcome this, like capacitive tripping circuits, and AC series tripping schemes, but each has its own disadvantages, and none are as reliable as the DC shunt tripping arrangement.

The circuit breaker opens its main contacts when the tripping signal has been received, interrupting the current.

From the protection point of view the important parts of the circuit breaker are the trip coil, latching mechanism, main contacts and auxiliary contacts.

Circuit breakers are normally fitted with a number of auxiliary contacts, which are used, as needed, in a variety of ways in control and protection circuits

Initially, circuit breakers used air as the insulating medium, later insulating oil (the oil also acting as a cooling medium), and nowadays vacuum or SF₆ (sulphur-hexafluoride) gas.

The connection between the relay and the circuit-breaker trip coil is purely electrical. This used to be one possible weak link in the trip circuit. One popular method to increase the reliability of the trip circuit for critical substations is to provide a full back-up trip supply. A back-up trip coil is installed in the circuit breaker, with back-up protection, powered by a second, independent BTU.

Figure 2.1 illustrates a typical arrangement.

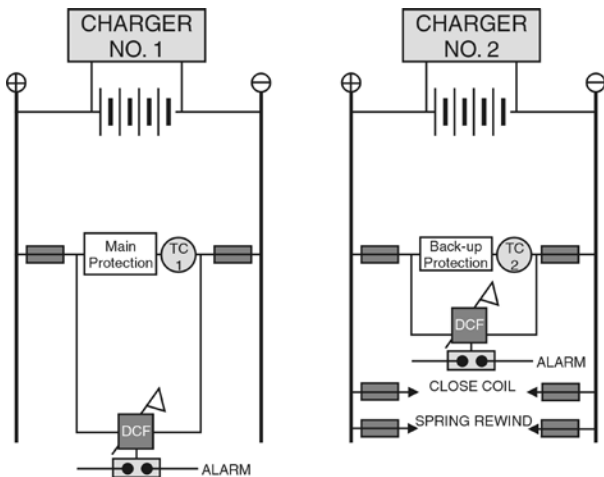

Figure 2.1
Arrangement of D. C. Supplies with Two Trip Coils for Each Circuit Breaker

Often a second set of contacts of the same relay is used for the back-up protection, which defeats the purpose of having full redundancy somewhat, as the relay itself then forms the weakest link.

A second method of increasing the reliability of the trip circuit, is to incorporate a trip circuit supervision relay, which continually monitors the continuity of the trip circuit, and activates an alarm when an unhealthy trip circuit is detected. One shortcoming of this method is that it cannot monitor the main protection relay itself.

Modern relays now have advanced self-monitoring and trip circuit supervision functionality, activating an alarm when it detects a fault within itself or in the trip circuit, increasing reliability of the complete trip circuit tremendously.

Circuit Breaker Tripping Times

The first characteristic is referred to as the "TRIPPING TIME" and is expressed in cycles.

Modern high-speed circuit breakers have tripping times between 3 and 8 cycles.

The TRIPPING, TOTAL BREAK TIME is made up as follows:

- (Tripping Time) Opening Time:
This represents the time between the instant of application of tripping power to the instant of mechanical separation of the main contacts.
- (Tripping Time) Arcing Time:
The time between the instant of mechanical separation of the main circuit breaker contacts to the instant of arc extinction

The sum of the above: **Opening Time + Arcing Time = Breaking Time**

Instrument Transformers

The three main tasks of instrument transformers are

- To transform currents or voltages from a usually high value to a value easy to handle for relays and instruments.
- To insulate the relays, metering and instruments from the primary high voltage system.
- To provide possibilities of standardizing the relays and instruments etc. to a few rated currents and voltages.

Current Transformer (CT) Magnetization Curve

This curve is the best method of determining Current Transformer (CT) performance. It is a graph of the amount of magnetizing current required to generate an open-circuit voltage at the terminals of the unit. Due to the non-linearity of the core iron, it follows the B-H loop characteristic and comprises three regions, namely the initial region, unsaturated region and saturated region.

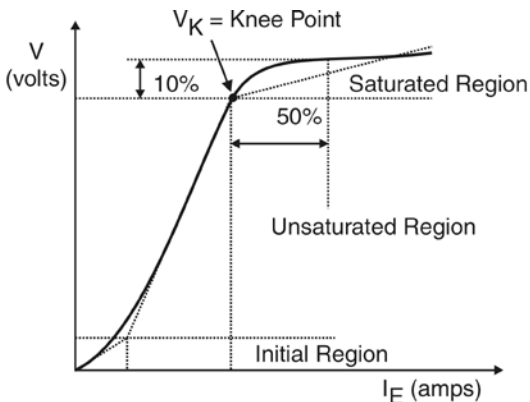

Figure 2.2
Typical CT Magnetization Curve.

Knee-Point Voltage

The transition from the unsaturated to the saturated region of the open circuit excitation characteristic is a rather gradual process in most core materials. It is difficult to define this transition and use is made of the so-called "knee-point" voltage for this purpose.

It is generally defined as the voltage at which a further 10% increase in volts will require a 50% increase in excitation current. For most applications, it means that current transformers can be considered as approximately linear up to this point.

Metering CTs

Instruments and meters are required to work accurately up to full load current, but above this it is advantageous to saturate to protect the instruments under fault conditions. They therefore have a very sharp knee-point and a special nickel-alloy metal is used, having a very low magnetizing current, in order to achieve the accuracy.

Protection CTs

Protective gear, on the other hand, is concerned with a wide range of currents from fault settings to maximum fault currents many times normal rating. Larger errors may be permitted and it is important to ensure that saturation is avoided wherever possible to ensure positive operation of the relays.

Open Circuiting of CTs

Current transformers generally work at a low flux density. The core is usually made of very good metal to give a small magnetizing current. When it is open circuit the secondary impedance now becomes infinite and the core deeply saturates.

-*- Flashover will then occur -*-

NEVER OPEN-CIRCUIT A C.T. ON LOAD!

As all of the primary current now becomes magnetizing current.

As the ac wave then moves from positive half cycle to the negative half cycle, the rate of change of flux $d\phi/dt$ is so great that very high voltages are induced in the secondary winding.

CT Specification

A current transformer is normally specified in terms of

- A rated burden at rated current.
- An accuracy class.
- An upper limit beyond which accuracy is not guaranteed.

(Known as the Accuracy Limit Factor, ALF).

Special (Class X) Current Transformers

These are normally specified for special purpose applications such as differential protection, where it is important that CTs have matching characteristics.

For this type of CT an exact point on the Magnetization Curve is specified, e.g.

- Rated primary current
- Turns ratio
- Rated knee point e.m.f. at maximum secondary turns
- Maximum exciting current at rated knee point e.m.f.
- Maximum resistance of secondary winding.

In addition, the error in the turn's ratio shall not exceed +/- 0.25%.

Voltage Transformers

There are two types of voltage transformer used for protection equipment, the purely electro-magnetic type (commonly referred to as a VT) and the Capacitor type (referred to as a CVT).

Magnetic Voltage Transformer

The magnetic voltage transformer is similar to a power transformer and differs only in so far as a different emphasis is placed on cooling, insulating and mechanical aspects.

The primary winding has a large number of turns and is connected across the line voltage either line-to-line or line-to-neutral.

The secondary has fewer turns, consequently as the volts per turn remains constant, then less voltage and higher currents are obtained.

Output burdens of 500 VA per phase are common.

Capacitive Transformer

The capacitor VT is more commonly used on high voltage networks. The capacitor allows the injection of a high frequency signal onto the power line conductors to provide end-to-end communications between substations for distance relays telemetry/supervisory and voice communications.

IDMT Relays

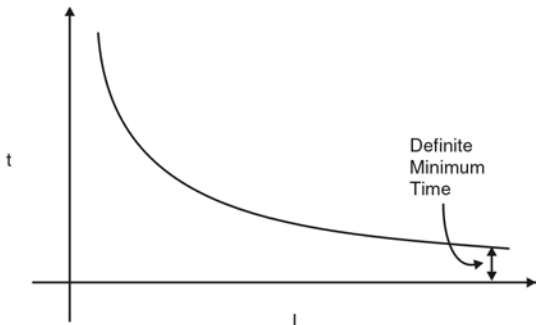

Figure 2.3
IDMT Relays

It can be seen that the operating time of an IDMT relay is inversely proportional to a function of current, i.e. it has a long operating time at low multiples of setting current and a relatively short operating time at high multiples of setting current.

Two adjustments are possible on the relay, namely:

Current (Tap) Setting

This setting determines the level of current at which the relay will pick-up or start. Increasing this value will move the IDMT curve to the right of the graph.

Time Dial Setting

This setting speeds up the tripping time of the relay, and has the effect of moving the inverse curve down the axis as follows:

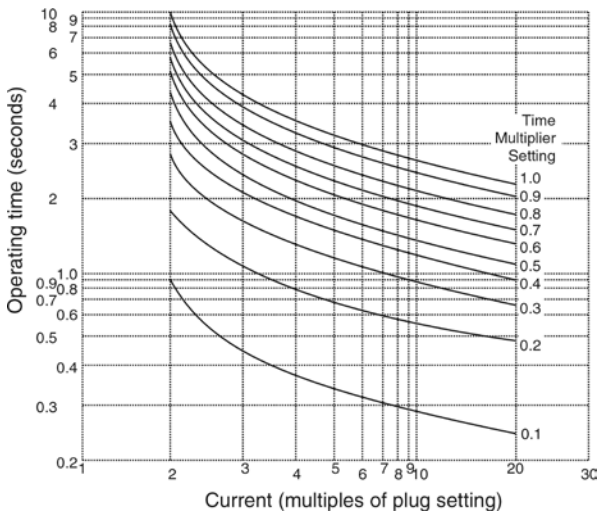

Figure 2.4
Time/Current Characteristic.

Other characteristic curves are also available, namely VERY INVERSE and EXTREMELY INVERSE. The time curves are shown as follows:

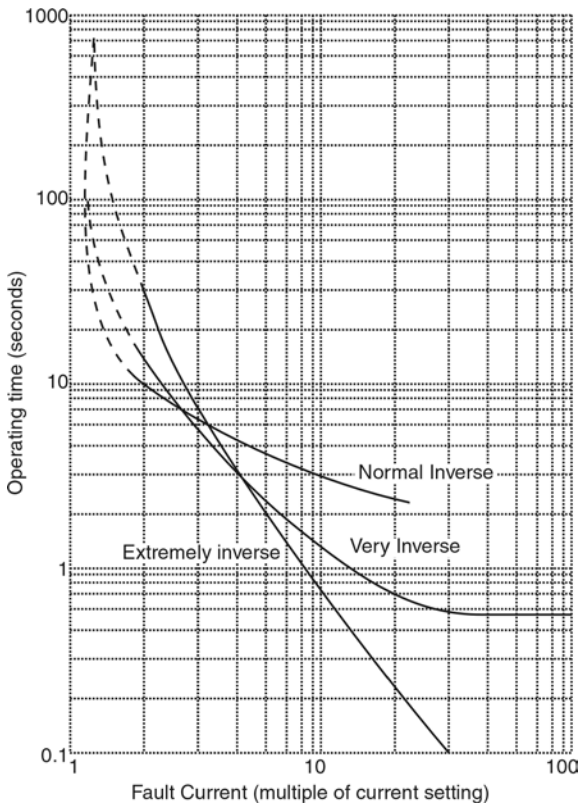

Figure 2.5
Example of Different Inverse Curves

Why IDMT?

To achieve selectivity and co-ordination by time grading two philosophies are available, namely:

- Definite Time Lag (DTL), or
- Inverse Definite Minimum Time (IDMT)

For the first option, the relays are graded using a definite time interval of approximately 0.5 seconds. The relay A at the extremity of the network is set to operate in the fastest possible time, whilst its upstream relay B is set 0.5 seconds higher. Relay operating times increase sequentially at 0.5-second intervals on each section moving back towards the source as shown in Figure 2.6.

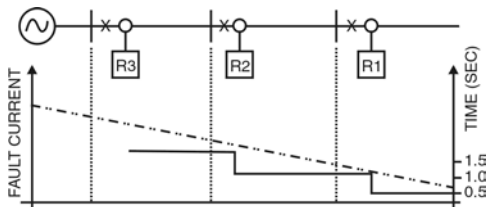

Figure 2.6
Definite Time Philosophy.

The problem with this philosophy is the closer the fault to the source, the higher the fault current, the slower the clearing time - exactly the opposite to what we should be trying to achieve!

On the other hand, inverse curves as shown in Figure 2.7 operate faster at higher fault currents and slower at the lower fault currents, thereby offering us the features that we desire.

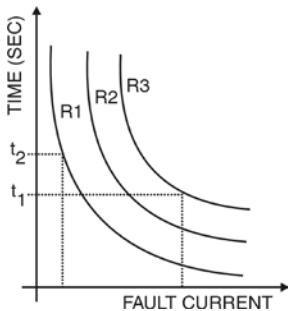

Figure 2.7
Inverse Definite Minimum Time.

This explains why the IDMT philosophy has become standard practice throughout many countries over the years.

Appendix A

Glossary of Terms

10BASE2	IEEE802.3 (or Ethernet) implementation on thin coaxial cable (RG58/AU).
10BASE5	IEEE802.3 (or Ethernet) implementation on thick coaxial cable.
10BASET	IEEE802.3 (or Ethernet) implementation on unshielded 22 AWG twisted pair cable.
A/D Conversion Time	This is the length of time a board requires to convert an analog signal into a digital value. The theoretical maximum speed (conversions/second) is the inverse of this value. See Speed/Typical Throughput.
A/D	Analog to Digital conversion.
Absolute Addressing	A mode of addressing containing both the instruction and location (address) of data.
Accuracy	Closeness of indicated or displayed value to the ideal measured value.
ACK	Acknowledge (ASCII - control F).
Acknowledge	A handshake line or protocol code which is used by the receiving device to indicate that it has read the transmitted data.
Active Device	Device capable of supplying current for a loop.
Active Filter	A combination of active circuit devices (usually amplifiers), with passive circuit elements (resistors and capacitors), which have characteristics that more closely match ideal filters than do passive filters.
Actuator	Control element or device used to modulate (or vary) a process parameter.
Address	A normally unique designator for location of data or the identity of a peripheral device which allows each device on a single communications line to respond to its own message.
Address Register	A register that holds the address of a location containing a data item called for by an instruction.
AFC	Automatic Frequency Control. The circuit in a radio receiver that automatically keeps the carrier frequency centred in the passband of the filters and demodulators.
AGC	Automatic Gain Control. The circuit in a radio that automatically keeps the carrier gain at the proper level.

Algorithm	Can be used as a basis for writing a computer program. This is a set of rules with a finite number of steps for solving a problem.
Alias Frequency	A false lower frequency component that appears in data reconstructed from original data acquired at an insufficient sampling rate (less than two times the maximum frequency of the original data).
ALU	see Arithmetic Logic Unit.
Amplitude Modulation	A modulation technique (also referred to as AM or ASK) used to allow data to be transmitted across an analog network, such as a switched telephone network. The amplitude of a single (carrier) frequency is varied or modulated between two levels; one for binary 0 and one for binary 1.
Analog	A continuous real-time phenomenon in which the information values are represented in a variable and continuous waveform.
Analog Input Board	Printed Circuit Board which converts incoming analog signals to digital values.
ANSI	American National Standards Institute. The principle standards development body in the USA.
Apogee	The point in an elliptical orbit that is furthest from earth.
Appletalk	A proprietary computer networking standard initiated by Apple Computer for use in connecting the Macintosh range of computers and peripherals (including Laser Writer printers). This standard operates at 230 kilobits/second.
Application Program	A sequence of instructions written to solve a specific problem facing organisational management. These programs are normally written in a high-level language and draw on resources of the operating system and the computer hardware in executing its tasks.
Application Layer	The highest layer of the seven layer ISO/OSI Reference Model structure, which contains all user or application programs.
Arithmetic Logic Unit	The element(s) in a processing system that perform(s) the mathematical functions such as addition, subtraction, multiplication, division, inversion, AND, OR, NAND and NOR.
ARP	Address Resolution Protocol. A Transmission Control Protocol/Internet Protocol (TCP/IP) process that maps an IP address to Ethernet address, required by TCP/IP for use with Ethernet.
ARQ	Automatic Request for Transmission. A request by the receiver for the transmitter to retransmit a block or a frame because of errors detected in the originally received message.
AS	Australian Standard.

ASCII	American Standard Code for Information Interchange. A universal standard for encoding alphanumeric characters into 7 or 8 binary bits. Drawn up by ANSI to ensure compatibility between different computer systems.
ASIC	Application Specific Integrated Circuit.
ASK	Amplitude Shift Keying. See Amplitude Modulation.
ASN.1	Abstract Syntax Notation One. An abstract syntax used to define the structure of the protocol data units associated with a particular protocol entity.
Asynchronous	Communications in which characters can be transmitted at an arbitrary, unsynchronised time, and where the time intervals between transmitted characters may be of varying lengths. Communication is controlled by start and stop bits at the beginning and end of each character.
Attenuation	The decrease in signal magnitude or strength between two points.
Attenuator	A passive network that decreases the amplitude of a signal (without introducing any undesirable characteristics to the signals such as distortion).
AUI CABLE	Attachment Unit Interface Cable. Sometimes called the drop cable to attach terminals to the transceiver unit.
Auto Tracking Antenna	A receiving antenna that moves in synchronism with the transmitting device which is moving (such as a vehicle being telemetered).
Autoranging	An autoranging board can be set to monitor the incoming signal and automatically select an appropriate gain level based on the previous incoming signals.
AWG	American Wire Gauge.
Background Program	An application program that can be executed whenever the facilities of the system are not needed by a higher priority program.
Backplane	A panel containing sockets into which circuit boards (such as I/O cards, memory boards and power supplies) can be plugged.
Balanced Circuit	A circuit so arranged that the impressed voltages on each conductor of the pair are equal in magnitude but opposite in polarity with respect to a defined reference.
Band Pass Filter	A filter that allows only a fixed range of frequencies to pass through. All other frequencies outside this range (or band) are sharply reduced in magnitude.
Band Reject	A circuit that rejects a defined frequency band of signals while passing all signals outside this frequency range (both lower than and higher than).

Bandwidth	The range of frequencies available, expressed as the difference between the highest and lowest frequencies, in hertz (cycles per second, abbreviated Hz).
Bar Code Symbol	An array of rectangular parallel bars and spaces of various widths designed for the labelling of objects with unique identifications. A bar code symbol contains a leading quiet zone, a start character, one or more data characters including, in some cases, a check character, a stop character, and a trailing quiet zone.
Base Address	A memory address that serves as the reference point. All other points are located by offsetting in relation to the base address.
Base Band	Base Band operation is the direct transmission of data over a transmission medium without the prior modulation on a high frequency carrier band.
Base Loading	An inductance situated near the bottom end of a vertical antenna to modify the electrical length. This aids in impedance matching.
Baud	Unit of signalling speed derived from the number of events per second (normally bits per second). However, if each event has more than one bit associated with it, the baud rate and bits per second are not equal.
Baudot	Data transmission code in which five bits represent one character. Sixty-four alphanumeric characters can be represented.
BCC	Block Check Character. Error checking scheme with one check character; a good example being Block Sum Check.
BCD	Binary Coded Decimal. A code used for representing decimal digits in a binary code.
BEL	Bell (ASCII for control-G).
BERT/BLERT	Bit Error Rate/Block Error Rate Testing. An error checking technique that compares a received data pattern with a known transmitted data pattern to determine transmission line quality.
Bifilar	Two conducting elements used in parallel (such as two parallel wires wound on a coil form).
Binary Coded Decimal	(BCD) A code used for representing decimal digits in a binary code.
BIOS	The basic input/output system for the computer, usually firmware-based. This program handles the interface with the PC hardware and isolates the Operating Software (OS) from the low-level activities of the hardware. As a result, application software becomes more independent of the particular specifications of the hardware on which it runs, and hence more portable.

Bipolar Range / Inputs	A signal range that includes both positive and negative values. Bipolar inputs are designed to accept both positive and negative voltages. (Example: ± 5 V).
Bisynchronous Transmission	See BSC.
Bit Stuffing with Zero Bit Insertion	A technique used to allow pure binary data to be transmitted on a synchronous transmission line. Each message block (frame) is encapsulated between two flags which are special bit sequences. Then if the message data contains a possibly similar sequence, an additional (zero) bit is inserted into the data stream by the sender, and is subsequently removed by the receiving device. The transmission method is then said to be data transparent.
BIT (Binary Digit)	Derived from "BInary DiGiT", a one or zero condition in the binary system.
Bits & Bytes	One bit is one binary digit, either a binary 0 or 1. One byte is the amount of memory needed to store each character of information (text or numbers). There are eight bits to one byte (or character), and there are 1024 bytes to one kilobyte (KB). There are 1024 kilobytes to one megabyte (MB).
Block	In block-structured programming languages, a section of programming languages or a section of program coding treated as a unit.
Block Sum Check	This is used for the detection of errors when data is being transmitted. It comprises a set of binary digits (bits) which are the modulo 2 sum of the individual characters or octets in a frame (block) or message.
BNC	Bayonet type coaxial cable connector.
bps	Bits per second. Unit of data transmission rate.
Bridge	A device to connect similar sub-networks without its own network address. Used mostly to reduce the network load.
Broad Band	A communications channel that has greater bandwidth than a voice grade line and is potentially capable of greater transmission rates.
Broadcast	A message on a bus intended for all devices which requires no reply.
BS	Backspace (ASCII Control-H).
BS	British Standard.
BSC	Bisynchronous Transmission. A byte or character oriented communication protocol that has become the industry standard (created by IBM). It uses a defined set of control characters for synchronised transmission of binary coded data between stations in a data communications system.

Bubble Memory	Describes a method of storing data in memory where data is represented as magnetized spots called magnetic domains that rest on a thin film of semiconductor material. Normally used in high-vibration, high-temperature or otherwise harsh industrial environments.
Buffer	An intermediate temporary storage device used to compensate for a difference in data rate and data flow between two device (also called a spooler for interfacing a computer and a printer).
Burst Mode	A high speed data transfer in which the address of the data is sent followed by back to back data words while a physical signal is asserted.
Bus	A data path shared by many devices, with one or more conductors for transmitting signals, data or power.
Byte	A term referring to eight associated bits of information; sometimes called a "character".
Cache Memory	A fast buffer memory that fits between the CPU and the slower main memory to speed up CPU requests for data.
Capacitance (mutual)	The capacitance between two conductors with all other conductors, including shield, short circuited to the ground.
Capacitance	Storage of electrically separated charges between two plates having different potentials. The value is proportional to the surface area of the plates and inversely proportional to the distance between them.
Cascade	Two or more electrical circuits in which the output of one is fed into the input of the next one.
Cassegrain Antenna	Parabolic antenna that has a hyperbolic passive reflector situated at the focus of the parabola.
CCD	Charge-Coupled Device (camera).
CCIR	Comité Consultatif Internationale des Radiocommunications.
CCITT	Consultative Committee International Telegraph and Telephone. An international association that sets worldwide standards (e.g. V.21, V.22, V.22bis).
Cellular Polyethylene	Expanded or "foam" polyethylene consisting of individual closed cells suspended in a polyethylene medium.
CGA	Color Graphics Adapter. A computer standard utilising digital signals offering a resolution of 320 by 200 pixels and a palette of 16 colors.
Channel Selector	In an FM discriminator the plug-in module which causes the device to select one of the channels and demodulate the subcarrier to recover data.
Character	Letter, numeral, punctuation, control figure or any other symbol contained in a message.

Characteristic Impedance	The impedance that, when connected to the output terminals of a transmission line of any length, makes the line appear infinitely long. The ratio of voltage to current at every point along a transmission line on which there are no standing waves.
Clock	The source of timing signals for sequencing electronic events such as synchronous data transfer or CPU operation in a PC.
Clock Pulse	A rising edge, then a falling edge (in that order) such as applied to the clock input of an 8254 timer/counter.
Clock	The source(s) of timing signals for sequencing electronic events eg synchronous data transfer.
Closed Loop	A signal path that has a forward route for the signal, a feedback network for the signal and a summing point.
CMRR	Common Mode Rejection Ratio - A data acquisition's board's ability to measure only the voltage difference between the leads of a transducer, rejecting what the leads have in common. The higher the CMRR, the better the accuracy.
CMV	Common Mode Voltage.
CNR	Carrier to Noise Ratio. An indication of the quality of the modulated signal.
Cold-junction Compensation	Thermocouple measurements can easily be affected by the interface the thermocouples are connected to. Cold-junction compensation circuitry compensates for inaccuracies introduced in the conversion process.
Collector	The voltage source in a transistor with the base as the control source and the emitter as the controlled output.
Collision	The situation when two or more LAN nodes attempt to transmit at the same time.
Common Carrier	A private data communications utility company that furnishes communications services to the general public.
Common Mode Signal	The common voltage to the two parts of a differential signal applied to a balanced circuit.
Commutator	A device used to effect time-division multiplexing by repetitive sequential switching.
Compiler	A program to convert high-level source code (such as BASIC) to machine code-executable form, suitable for the CPU.
Composite Link	The line or circuit connecting a pair of multiplexers or concentrators; the circuit carrying multiplexed data.
Composite	A video signal that contains all the intensity, color and timing information necessary for a video product.

Conical Scan Antenna	An automatic tracking antenna system in which the beam is steered in a circular path so that it forms a cone.
Contention	The facility provided by the dial network or a data PABX which allows multiple terminals to compete on a first come, first served basis for a smaller number of computer ports.
Control System	A system in which a series of measured values are used to make a decision on manipulating various parameters in the system to achieve a desired value of the original measured values.
Convolution	An image enhancement technique in which each pixel is subjected to a mathematical operation that groups it with its nearest neighbours and calculates its value accordingly.
Correlator	A device which compares two signals and indicates the similarity between the two signals.
Counter/ Timer Trigger	On-board counter/timer circuitry can be set to trigger data acquisition at a user-selectable rate and for a particular length of time.
Counter Data Register	The 8-bit register of an (8254 chip) timer/counter that corresponds to one of the two bytes in the counter's output latch for read operations and count register for write operations.
CPU	Central Processing Unit.
CR	Carriage Return (ASCII control-M).
CRC	Cyclic Redundancy Check. An error-checking mechanism using a polynomial algorithm based on the content of a message frame at the transmitter and included in a field appended to the frame. At the receiver, it is then compared with the result of the calculation that is performed by the receiver. Also referred to as CRC-16.
Cross Talk	A situation where a signal from a communications channel interferes with an associated channel's signals.
Crossed Pinning	Wiring configuration that allows two DTE or DCE devices to communicate. Essentially it involves connecting pin 2 to pin 3 of the two devices.
Crossover	In communications, a conductor which runs through the cable and connects to a different pin number at each end.
Crosstalk	A situation where a signal from a communications channel interferes with an associated channel's signals.
CSMA/CD	Carrier Sense Multiple Access/Collision Detection. When two devices transmit at the same time on a local area network, they both cease transmission and signal that a collision has occurred. Each then tries again after waiting for a random time period.

Current Sink	This is the amount of current the board can supply for digital output signals. With 10-12 mA or more of current sink capability, a board can turn relays on and off. Digital I/O boards with less than 10-12 mA of sink capability are designed for data transfer only, not for hardware power relay switching.
Current Loop	<p>A communication method that allows data to be transmitted over a longer distance with a higher noise immunity level than with the standard RS-232C voltage method.</p> <p>A mark (a binary 1) is represented by current; and a space (or binary 0) is represented by the absence of current.</p>
Current Inputs	A board rated for current inputs can accept and convert analog current levels directly, without conversion to voltage.
D/A	Digital to Analog.
DAS	Data Acquisition System.
Data Integrity	A performance measure based on the rate of undetected errors.
Data Reduction	The process of analysing a large quantity of data in order to extract some statistical summary of the underlying parameters.
Data Link Layer	This corresponds to layer 2 of the ISO Reference Model for open systems interconnection. It is concerned with the reliable transfer of data (no residual transmission errors) across the data link being used.
Data Integrity	A performance measure based on the rate of undetected errors.
Datagram	A type of service offered on a packet-switched data network. A datagram is a self contained packet of information that is sent through the network with minimum protocol overheads.
dB _i	A unit that is used to represent the gain of an antenna compared to the gain of an isotropic radiator.
dB _m	A signal level that is compared to a 1-mW reference.
dB _{mV}	A signal amplitude that is compared to a 1-mV reference.
dBW	A signal amplitude that is compared to a 1-Watt reference.
DCE	Data Communications Equipment. Devices that provide the functions required to establish, maintain and terminate a data transmission connection. Normally it refers to a modem.
Decibel	A logarithmic measure of the ratio of two signal levels where $dB = 20\log_{10} V_1/V_2$. Being a ratio, it has no units of measure.
Decibel (dB)	A logarithmic measure of the ratio of two signal levels where $dB = 20\log_{10} V_1/V_2$ or where $dB = 10\log_{10} P_1/P_2$ and where V refers to Voltage or P refers to Power. Note that it has no unit of measure.

Decoder	A device that converts a combination of signals into a single signal representing that combination.
Decommutator	Equipment for the demultiplexing of commutated signals.
Default	A value or setup condition assigned automatically unless another is specified.
Delay Distortion	Distortion of a signal caused by the frequency components making up the signal having different propagation velocities across a transmission medium.
DES	Data Encryption Standard.
Deviation	A movement away from a required value.
DFB	Display Frame Buffer.
Diagnostic Program	A utility program used to identify hardware and firmware defects related to the PC.
Dielectric Constant (E)	The ratio of the capacitance using the material in question as the dielectric, to the capacitance resulting when the material is replaced by air.
Differential	See Number of channels.
Digital	A signal which has definite states (normally two).
Digitize	The transformation of an analog signal to a digital signal.
DIN	Deutsches Institut Fur Normierung.
DIP	Acronym for dual in line package referring to integrated circuits and switches.
Diplexing	A device used to allow simultaneous reception or transmission of two signals on a common antenna.
Direct Memory Access	A technique of transferring data between the computer memory and a device on the computer bus without the intervention of the micro-processor. Also abbreviated to DMA.
Discriminator	Hardware device to demodulate a frequency modulated carrier or subcarrier to produce analog data.
Dish Antenna	An antenna in which a parabolic dish acts a reflector to increase the gain of the antenna.
Dish	Concave antenna reflector for use at VHF or higher frequencies.
Diversity Reception	Two or more radio receivers connected to different antennas to improve signal quality by using two different radio signals to transfer the information.
DLE	Data Link Escape (ASCII character).
DMA	Direct Memory Access.

DNA	Distributed Network Architecture.
Doppler	The change in observed frequency of a signal caused by the emitting device moving with respect to the observing device.
Downlink	The path from a satellite to an earth station.
DPI	Dots per Inch.
DPLL	Digital Phase Locked Loop.
DR	Dynamic Range. The ratio of the full scale range (FSR) of a data converter to the smallest difference it can resolve. $DR = 2^n$ where n is the resolution in bits.
DRAM	Dynamic Random Access Memory. See RAM.
Drift	A gradual movement away from the defined input/output condition over a period of time.
Driver Software	A program that acts as the interface between a higher level coding structure and the lower level hardware/firmware component of a computer.
DSP	Digital Signal Processing.
DSR	Data Set Ready. An RS-232 modem interface control signal which indicates that the terminal is ready for transmission.
DTE	Data Terminal Equipment. Devices acting as data source, data sink, or both.
Dual-ported RAM	Allows acquired data to be transferred from on-board memory to the computer's memory while data acquisition is occurring.
Duplex	The ability to send and receive data over the same communications line.
Dynamic Range	The difference in decibels between the overload or maximum and minimum discernible signal level in a system.
EBCDIC	Extended Binary Coded Decimal Interchange Code. An 8-bit character code used primarily in IBM equipment. The code allows for 256 different bit patterns.
EEPROM	Electrically Erasable Programmable Read Only Memory. This memory unit can be erased by applying an electrical signal to the EEPROM and then reprogrammed.
EGA	Enhanced Graphics Adapter. A computer display standard that provides a resolution of 640 by 350 pixels, a palette of 64 colors, and the ability to display as many as 16 colors at one time.
EIA	Electronic Industries Association. An organisation in the USA specialising in the electrical and functional characteristics of interface equipment.

EIA-232-C	Interface between DTE and DCE, employing serial binary data exchange. Typical maximum specifications are 15m at 19200 Baud.
EIA-423	Interface between DTE and DCE, employing the electrical characteristics of unbalanced voltage digital interface circuits.
EIA-449	General purpose 37 pin and 9 pin interface for DCE and DTE employing serial binary interchange.
EIA-485	The recommended standard of the EIA that specifies the electrical characteristics of drivers and receivers for use in balanced digital multipoint systems.
EIRP	Effective Isotropic Radiated Power. The effective power radiated from a transmitting antenna when an isotropic radiator is used to determine the gain of the antenna.
EISA	Enhanced Industry Standard Architecture.
EMI/RFI	Electro-Magnetic Interference or Radio Frequency Interference. Background 'noise' capable of modifying or destroying data transmission.
EMS	Expanded Memory Specification.
Emulation	The imitation of a computer system performed by a combination of hardware and software that allows programs to run between incompatible systems.
Enabling	The activation of a function of a device by a defined signal.
Encoder	A circuit which changes a given signal into a coded combination for purposes of optimum transmission of the signal.
ENQ	Enquiry (ASCII Control-E).
EOT	End of Transmission (ASCII Control-D).
EPROM	Erasable Programmable Read Only Memory. Non-volatile semiconductor memory that is erasable in a ultra violet light and reprogrammable.
Equalizer	The device which compensates for the unequal gain characteristic of the signal received.
Error Rate	The ratio of the average number of bits that will be corrupted to the total number of bits that are transmitted for a data link or system.
Error	The difference between the setpoint and the measured value.
ESC	Escape (ASCII character).
ESD	Electrostatic Discharge.
Ethernet	Name of a widely used Local Area Network (LAN), based on the CSMA/CD bus access method (IEEE 802.3).
ETX	End of Text (ASCII control-C).

Even Parity	A data verification method normally implemented in hardware in which each character (and the parity bit) must have an even number of ON bits.
External Pulse Trigger	Many of the A/D boards allow sampling to be triggered by a voltage pulse from an external source.
Fan In	The load placed on a signal line by a logic circuit input.
Fan Out	The measure of drive capability of a logic circuit output.
Farad	Unit of capacitance whereby a charge of one coulomb produces a one volt potential difference.
FCC	Federal Communications Commission (USA).
FCS	Frame Check Sequence. A general term given to the additional bits appended to a transmitted frame or message by the source to enable the receiver to detect possible transmission errors.
FDM	Frequency Division Multiplexer. A device that divides the available transmission frequency range in narrower bands, each of which is used for a separate channel.
Feedback	A part of the output signal being fed back to the input of the amplifier circuit.
Field	One half of a video image (frame) consisting of 312.5 lines (for PAL). There are two fields in a frame. Each is shown alternately every 1/25 of a second (for PAL).
FIFO	First in, First Out.
Filled Cable	A telephone cable construction in which the cable core is filled with a material that will prevent moisture from entering or passing along the cable.
FIP	Factory Instrumentation Protocol.
Firmware	A computer program or software stored permanently in PROM or ROM or semi-permanently in EPROM.
Flame Retardancy	The ability of a material not to propagate flame once the flame source is removed.
Floating	An electrical circuit that is above the earth potential.
Flow Control	The procedure for regulating the flow of data between two devices preventing the loss of data once a device's buffer has reached its capacity.
Frame	A full video image comprising two fields. A PAL frame has a total of 625 lines (an NTSC frame has 525 lines).
Frame	The unit of information transferred across a data link. Typically, there are control frames for link management and information frames for the transfer of message data.

Frame Grabber	An image processing peripheral that samples, digitizes and stores a camera frame in computer memory.
Frequency Modulation	A modulation technique (abbreviated to FM) used to allow data to be transmitted across an analog network where the frequency is varied between two levels - one for binary '0' and one for binary '1'. Also known as Frequency Shift Keying (or FSK).
Frequency	Refers to the number of cycles per second.
Frequency Domain	The displaying of electrical quantities versus frequency.
Fringing	The unwanted bordering of an object or character with weak colors when there should be a clearly delineated edge.
Full Duplex	Simultaneous two way independent transmission in both directions (4 wire). See Duplex.
G	Giga (metric system prefix - 10^9).
Gain of Antenna	The difference in signal strengths between a given antenna and a reference isotropic antenna.
Gain	Amplification; applied to an incoming signal, gain acts as a multiplication factor on the signal, enabling a board to use signals that would otherwise be too weak. For example, when set to a gain of 10, a board with a range of +5 V can use raw input signals as low as +0.5 V (+500 mV); with a gain of 20, the range extends down to +250 mV.
Gateway	A device to connect two different networks which translates the different protocols.
Genlock	This is the process of synchronising one video signal to a master reference, ensuring that all signals will be compatible or related to one another.
Geostationary	A special earth orbit that allows a satellite to remain in a fixed position above the equator.
Geosynchronous	Any earth orbit in which the time required for one revolution of a satellite is an integral portion of a sidereal day.
GPIB	General Purpose Interface Bus. An interface standard used for parallel data communication, usually used for controlling electronic instruments from a computer. Also designated IEEE-488 standard.
Graphics Mode	In graphics mode each pixel on a display screen is addressable, and each pixel has a horizontal (or X) and a vertical (or Y) co-ordinate.
Grey Scale	In image processing, the range of available grey levels. In an 8-bit system, the grey scale contains values from 0 to 255.

Ground	An electrically neutral circuit having the same potential as the earth. A reference point for an electrical system also intended for safety purposes.
Half Duplex	Transmissions in either direction, but not simultaneously.
Half Power Point	The point in a Power versus frequency curve which is half the power level of the peak power (also called the 3dB point).
Hamming Distance	A measure of the effectiveness of error checking. The higher the Hamming Distance (HD) index, the safer is the data transmission.
Handshake Lines	Dedicated signals which allow two different devices to exchange data under asynchronous hardware control.
Handshaking	Exchange of predetermined signals between two devices establishing a connection.
Harmonic	An oscillation of a periodic quantity whose frequency is an integral multiple of the fundamental frequency. The fundamental frequency and the harmonics together form a Fourier series of the original wave form.
Harmonic Distortion	Distortion caused by the presence of harmonics in the desired signal.
HDLC	High Level Data Link Control. The international standard communication protocol defined by ISO to control the exchange of data across either a point-to-point data link or a multidrop data link.
Hertz (Hz)	A term replacing cycles per second as a unit of frequency.
Hex	Hexadecimal.
Hexadecimal Number	A base 16 number system commonly used with microprocessor systems.
HF	High Frequency.
High Pass	Generally referring to filters which allow signals above a specified frequency to pass but attenuate signals below this specified frequency.
High-Pass Filter	See HPF.
Histogram	A graphic representation of a distribution function, such as frequency, by means of rectangles whose widths represent the intervals into which the range of observed values is divided and whose heights represent the number of observations occurring in each interval.
Horn	A moderate-gain wide-beamwidth antenna.
Host	This is normally a computer belonging to a user that contains (hosts) the communication hardware and software necessary to connect the computer to a data communications network.
HPF	High-Pass Filter. A filter processing one transmission band that extends from a cutoff frequency (other than zero) to infinity.

HPIB	Hewlett-Packard Interface Bus; trade name used by Hewlett-Packard for its implementation of the IEEE-488 standard.
I/O Address	A method that allows the CPU to distinguish between different boards in a system. All boards must have different addresses.
IEC	International Electrotechnical Commission.
IEE	Institution of Electrical Engineers.
IEEE	Institute of Electrical and Electronic Engineers. A US-based international professional society that issues its own standards and, which is a member of ANSI and ISO.
Illumination Component	An amount of source light incident on the object being viewed.
Impedance	The total opposition that a circuit offers to the flow of alternating current or any other varying current at a particular frequency. It is a combination of resistance R and reactance X, measured in ohms.
Individual Gain per Channel	A system allowing an individual gain level for each input channel, thereby allowing a much wider range of input levels and types without sacrificing accuracy on low-level signals.
Inductance	The property of a circuit or circuit element that opposes a change in current flow, thus causing current changes to lag behind voltage changes. It is measured in henrys.
Insulation Resistance (IR)	That resistance offered by an insulation to an impressed dc voltage, tending to produce a leakage current through the insulation.
Interface	A shared boundary defined by common physical interconnection characteristics, signal characteristics and measuring of interchanged signals.
Interlace	This is the display of two fields alternately with one field filling in the blank lines of the other field so that they interlock. The PAL standard displays 25 video frames per second.
Interlaced	Interlaced - describing the standard television method of raster scanning, in which the image is the product of two fields, each of which is a series of successively scanned lines separated by the equivalent of one line. Thus adjacent lines belong to different fields.
Interrupt	An external event indicating that the CPU should suspend its current task to service a designated activity.
Interrupt Handler	The section of the program that performs the necessary operation to service an interrupt when it occurs.
IP	Internet Protocol.
ISA	Industry Standard Architecture (for IBM Personal Computers).
ISA	Instrument Society of America.
ISB	Intrinsically Safe Barrier.

ISDN	Integrated Services Digital Network. A fairly recent generation of worldwide telecommunications networks that utilize digital techniques for both transmission and switching. It supports both voice and data communications.
ISO	International Standards Organisation.
Isolation	Electrical separation of two circuits. For example, optical isolation allows a high-voltage signal to be transferred to a low-voltage input without electrical interactions.
Isotropic Antenna	A reference antenna that radiates energy in all directions from a point source.
ISR	Interrupt Service Routine. See Interrupt Handler.
ITU	International Telecommunications Union.
Jabber	Garbage that is transmitted when a LAN node fails and then continuously transmits.
Jumper	A wire connecting one or more pins (on the one end of a cable only, for example).
k (kilo)	Typically multiples of a thousand (e.g. 1 kilometer = 1000 meters)
K	In computer terminology, a K is $2^{10}=1024$. This distinguishes it from the SI unit k (kilo) which is 1000.
LAN	Local Area Network. A data communications system confined to a limited geographic area typically about 10 kms with moderate to high data rates (100kbps to 50 Mbps). Some type of switching technology is used, but common carrier circuits are not used.
LCD	Liquid Crystal Display. A low power display system used on many laptops and other digital equipment.
LDM	Limited Distance Modem. A signal converter which conditions and boosts a digital signal so that it may be transmitted further than a standard EIA-232 signal.
Leased (or Private) Line	A private telephone line without inter-exchange switching arrangements.
LED	Light Emitting Diode. A semi-conductor light source that emits visible light or infra red radiation.
LF	Line Feed (ASCII Control-J).
Line Driver	A signal converter that conditions a signal to ensure reliable transmission over an extended distance.
Line Turnaround	The reversal of transmission direction from transmitter to receiver or vice versa when a half duplex circuit is used.
Linearity	A relationship where the output is directly proportional to the input.

Link Layer	Layer 2 of the OSI reference model; also known as the data link layer.
Listener	A device on the GPIB bus that receives information from the bus.
LLC	Logical Link Control (IEEE 802.2).
Loaded Line	A telephone line equipped with loading coils to add inductance in order to minimize amplitude distortion.
Long Wire	A horizontal wire antenna that is one wavelength or greater in size.
Loop Resistance	The measured resistance of two conductors forming a circuit.
Loopback	Type of diagnostic test in which the transmitted signal is returned to the sending device after passing through all, or a portion, of a data communication link or network. A loopback test permits the comparison of a returned signal with the transmitted signal.
Low Pass	Generally referring to filters which allow signals below a specified frequency to pass but attenuate a signal above this specified frequency.
Low-Pass Filter	See LPF.
LPF	Low-Pass Filter. A filter processing one transmission band, extending from zero to a specific cutoff frequency.
LSB	Least Significant Byte or Least Significant Bit.
Luminance	The black and white portion of a video signal which supplies brightness and detail for the picture.
LUT	Look-Up Table. This refers to the memory that stores the values for the point processes. Input pixel values are those for the original image whilst the output values are those displayed on the monitor as altered by the chosen point processes.
Lux	SI unit of luminous incidence of illuminance, equal to one lumen per square metre.
Lux-second	SI unit of light exposure.
m	meter. Metric system unit for length.
M	Mega. Metric system prefix for 10^6 .
MAC	Media Access Control (IEEE 802).
Manchester Encoding	Digital technique (specified for the IEEE-802.3 Ethernet baseband network standard) in which each bit period is divided into two complementary halves; a negative to positive voltage transition in the middle of the bit period designates a binary "1", whilst a positive to negative transition represents a "0". The encoding technique also allows the receiving device to recover the transmitted clock from the incoming data stream (self clocking).

MAP	Manufacturing Automation Protocol. A suite of network protocols originated by General Motors which follow the seven layers of the OSI model. A reduced implementation is referred to as a mini-MAP.
Mark	This is equivalent to a binary 1.
Mask	A structure covering certain portions of a photo-sensitive medium during photographic processing.
Masking	Setting portions of an image at a constant value, either black or white. Also the process of outlining an image and then matching it to test images.
Master/Slave	Bus access method whereby the right to transmit is assigned to one device only, the Master, and all the other devices, the Slaves may only transmit when requested.
Master Oscillator	The primary oscillator for controlling a transmitter or receiver frequency. The various types are: Variable Frequency Oscillator (VFO); Variable Crystal Oscillator (VXO); Permeability Tuned Oscillator (PTO); Phase Locked Loop (PLL); Linear Master Oscillator (LMO) or frequency synthesizer.
Media Access Unit	Referred to often as MAU. This is the Ethernet transceiver unit situated on the coaxial cable which then connects to the terminal with a drop cable.
Microwave	AC signals having frequencies of 1 GHz or more.
MIPS	Million Instructions per second.
MMS	Manufacturing Message Services. A protocol entity forming part of the application layer. It is intended for use specifically in the manufacturing or process control industry. It enables a supervisory computer to control the operation of a distributed community of computer based devices.
Modem	MODulator - DEModulator. A device used to convert serial digital data from a transmitting terminal to a signal suitable for transmission over a telephone channel or to reconvert the transmitted signal to serial digital data for the receiving terminal.
Modem Eliminator	A device used to connect a local terminal and a computer port in lieu of the pair of modems to which they would ordinarily connect, allow DTE to DTE data and control signal connections otherwise not easily achieved by standard cables or connections.
Modulation Index	The ratio of the frequency deviation of the modulated wave to the frequency of the modulating signal.
Morphology	The study of a structure/form of object in an image.
MOS	Metal Oxide Semiconductor.
MOV	Metal Oxide Varistor.

MSB	Most Significant Byte or Most Significant Bit.
MTBF	Mean Time Between Failures.
MTTR	Mean Time To Repair.
Multidrop	A single communication line or bus used to connect three or more points.
Multiplexer (MUX)	A device used for division of a communication link into two or more channels, either by using frequency division or time division.
Multiplexer	A technique in which multiple signals are combined into one channel. They can then be demultiplexed back into the original components.
NAK	Negative Acknowledge (ASCII Control-U).
Narrowband	A device that can only operate over a narrow band of frequencies.
Negative True Logic	The inversion of the normal logic where the negative state is considered to be TRUE (or 1) and the positive voltage state is considered to be FALSE (or 0).
Network Layer	Layer 3 in the OSI model; the logical network entity that services the transport layer responsible for ensuring that data passed to it from the transport layer is routed and delivered throughout the network.
Network Architecture	A set of design principles including the organisation of functions and the description of data formats and procedures used as the basis for the design and implementation of a network (ISO).
Network	An interconnected group of nodes or stations.
Network Topology	The physical and logical relationship of nodes in a network; the schematic arrangement of the links and nodes of a network typically in the form of a star, ring, tree or bus topology.
NMRR	Normal Mode Rejection Ratio - The ability of a board to filter out noise from external sources, such as AC power lines. NMRR filtering compensates for transient changes in the incoming signal to provide greater accuracy. The higher the NMRR, the better the filtering of incoming data will be.
Node	A point of interconnection to a network.
Noise	A term given to the extraneous electrical signals that may be generated or picked up in a transmission line. If the noise signal is large compared with the data carrying signal, the latter may be corrupted resulting in transmission errors.
Non-linearity	A type of error in which the output from a device does not relate to the input in a linear manner.
NRZ	Non Return to Zero. Pulses in alternating directions for successive 1 bits but no change from existing signal voltage for 0 bits.

NRZI	Non Return to Zero Inverted.
NTSC	National Television System Committee (USA). A television standard specifying 525 lines and 60 fields per second.
Null Modem	A device that connects two DTE devices directly by emulating the physical connections of a DCE device.
Number of Channels	This is the number of input lines a board can sample. Single-ended inputs share the same ground connection, while differential inputs have individual two-wire inputs for each incoming signal, allowing greater accuracy and signal isolation. See also multiplexer.
Nyquist Sampling Theorem	In order to recover all the information about a specified signal it must be sampled at least at twice the maximum frequency component of the specified signal.
OCR	Optical Character Recognition, optical character reader.
ohm	Unit of resistance such that a constant current of one ampere produces a potential difference of one volt across a conductor.
OLUT	Output Look-Up Table.
On-board Memory	Incoming data is stored in on-board memory before being dumped into the PC's memory. On a high-speed board, data is acquired at a much higher rate than can be written into PC memory, so it is stored in the on-board buffer memory.
Optical Isolation	Two networks with no electrical continuity in their connection because an optoelectronic transmitter and receiver has been used.
OR	Outside Radius.
OSI	Open Systems Interconnection. A set of defined protocol layers with a standardized interface which allows equipment from different manufacturers to be connected.
Output	An analog or digital output control type signal from the PC to the external 'real world'.
Overlay	One video signal superimposed on another, as in the case of computer-generated text over a video picture.
Packet	A group of bits (including data and call control signals) transmitted as a whole on a packet switching network. Usually smaller than a transmission block.
PAD	Packet Access Device. An interface between a terminal or computer and a packet switching network.
PAL	Phase Alternating Lines. This is the television standard used in Europe and Australia. The PAL standard is 25 frames per second with 625 lines.

Parallel Transmission	The transmission model where multiple data bits are sent simultaneously over separate parallel lines. Accurate synchronisation is achieved by using a timing (strobe) signal. Parallel transmission is usually unidirectional; an example would be the Centronics interface to a printer.
Parametric Amplifier	An inverting parametric device for amplifying a signal without frequency translation from input to output.
Parasitic	Undesirable electrical parameter in a circuit such as oscillations or capacitance.
Parity Bit	A bit that is set to a "0" or "1" to ensure that the total number of 1 bits in the data and parity fields are even or odd.
Parity Check	The addition of non information bits that make up a transmission block to ensure that the total number of data and parity bits is always even (even parity) or odd (odd parity). Used to detect transmission errors but rapidly losing popularity because of its weakness in detecting errors.
Passive Filter	A circuit using only passive electronic components such as resistors, capacitors and inductors.
Passive Device	Device that must draw its power from connected equipment.
Path Loss	The signal loss between transmitting and receiving antennas.
PBX	Private Branch Exchange.
PCIP	Personal Computer Instrument Products.
PCM	Pulse Code Modulation. The sampling of a signal and encoding the amplitude of each sample into a series of uniform pulses.
PDU	Protocol Data Unit.
PEP	Peak Envelope Power. Maximum amplitude that can be achieved with any combination of signals.
Perigee	The point in an elliptical orbit that is closest to earth.
Peripherals	The input/output and data storage devices attached to a computer e.g. disk drives, printers, keyboards, display, communication boards, etc.
Phase Shift Keying	A modulation technique (also referred to as PSK) used to convert binary data into an analog form comprising a single sinusoidal frequency signal whose phase varies according to the data being transmitted.
Phase Modulation	The sine wave or carrier has its phase changed in accordance with the information to be transmitted.
Physical Layer	Layer 1 of the ISO/OSI Reference Model, concerned with the electrical and mechanical specifications of the network termination equipment.

PIA	Peripheral Interface Adapter. Also referred to as PPI (Programmable Peripheral Interface).
Pixel	One element of a digitized image, sometimes called picture element, or pel.
PLC	Programmable Logic Controller.
PLL	Phase Locked Loop
Point to Point	A connection between only two items of equipment.
Polar Orbit	The path followed when the orbital plane includes the north and south poles.
Polarisation	The direction of an electric field radiated from an antenna.
Polling	A means of controlling I/O devices on a multipoint line in which the CPU queries ('polls') the devices at regular intervals to check for data awaiting transfer (to the CPU). Slower and less efficient than interrupt driven I/O operations.
Polyethylene	A family of insulators derived from the polymerisation of ethylene gas and characterized by outstanding electrical properties, including high IR, low dielectric constant, and low dielectric loss across the frequency spectrum.
Polyvinyl Chloride (PVC)	A general purpose family of insulations whose basic constituent is polyvinyl chloride or its copolymer with vinyl acetate. Plasticisers, stabilizers, pigments and fillers are added to improve mechanical and/ or electrical properties of this material.
Port	A place of access to a device or network, used for input/output of digital and analog signals.
PPI	See PIA.
Presentation Layer	Layer 6 of the ISO/OSI Reference Model, concerned with negotiation of a suitable transfer syntax for use during an application. If this is different from the local syntax, the translation is to/from this syntax.
Pretrigger	Boards with 'pretrigger' capability keep a continuous buffer filled with data, so when the trigger conditions are met, the sample includes the data leading up to the trigger condition.
Profibus	Process Field Bus developed by a consortium of mainly German companies with the aim of standardisation.
Program I/O	The standard method of memory access, where each piece of data is assigned to a variable and stored individually by the PC's processor.

Programmable Gain	Using an amplifier chip on an A/D board, the incoming analog signal is increased by the gain multiplication factor. For example; if the input signal is in the range of -250 mV to +250 mV, the voltage after the amplifier chip set to a gain of 10 would be -2.5 V to +2.5 V.
PROM	Programmable Read Only Memory. This is programmed by the manufacturer as a fixed data or program which cannot easily be changed by the user.
Protocol Entity	The code that controls the operation of a protocol layer.
Protocol	A formal set of conventions governing the formatting, control procedures and relative timing of message exchange between two communicating systems.
PSDN	Public Switched Data Network. Any switching data communications system, such as Telex and public telephone networks, which provides circuit switching to many customers.
PSTN	Public Switched Telephone Network. This is the term used to describe the (analog) public telephone network.
PTT	Post, Telephone and Telecommunications Authority.
Public Switched Network	Any switching communications system - such as Telex and public telephone networks - that provides circuit switching to many customers.
Pulse Input	A square wave input from a real world device such as a flow meter, which sends pulses proportional to the flow rate.
QAM	Quadrature Amplitude Modulation.
QPSK	Quadrature Phase Shift Keying.
Quagi	An antenna consisting of both full wavelength loops (quad) and Yagi elements.
R/W	Read/Write.
RAM	Random Access Memory. Semiconductor read/write volatile memory. Data is lost if the power is turned off.
RAMDAC	Random Access Memory Digital-to-Analog Converter.
Range	The difference between the upper and lower limits of the measured value.
Range Select	The full-scale range a board uses is selected by one of three methods: through the appropriate software, by a hardware jumper on the board, or through the use of an external reference voltage.
Raster	The pattern of lines traced by rectilinear scanning in display systems.
Reactance	The opposition offered to the flow of alternating current by inductance or capacitance of a component or circuit.

Real-time	A system is capable of operating in real-time when it is fast enough to react to the real-world events.
Reflectance Component	The amount of light reflected by an object in the scene being viewed.
Refresh rate	The speed at which information is updated on a computer display (CRT).
Repeater	An amplifier which regenerates the signal and thus expands the network.
Resistance	The ratio of voltage to electrical current for a given circuit measured in ohms.
Resolution	The number of bits in which a digitized value will be stored. This represents the number of divisions into which the full-scale range will be divided; for example, a 0-10 V range with a 12-bit resolution will have $4096(2^{12})$ divisions of 2.44mV each.
Response Time	The elapsed time between the generation of the last character of a message at a terminal and the receipt of the first character of the reply. It includes terminal delay and network delay.
RF	Radio Frequency.
RFI	Radio Frequency Interference.
RGB	Red/Green/Blue. An RGB signal has four separate elements; red/green/ blue and sync. This results in a cleaner image than with composite signals due to the lower level of distortion and interference.
Ring	Network topology commonly used for interconnection of communities of digital devices distributed over a localized area, e.g. a factory or office block. Each device is connected to its nearest neighbours until all the devices are connected in a closed loop or ring. Data are transmitted in one direction only. As each message circulates around the ring, it is read by each device connected in the ring.
Ringing	An undesirable oscillation or pulsating current.
Rise Time	The time required for a waveform to reach a specified value from some smaller value.
RLE	Run Length Encoder. A digital image method whereby the first grey level of each sequential point-by-point sample and its position in the succession of grey levels is encoded. It is used where there is a tendency for long runs of repeated digitized grey levels to occur.
RMS	Root Mean Square.
ROI	Region of Interest.

ROM	Read Only Memory. Computer memory in which data can be routinely read but written to only once using special means when the ROM is manufactured. A ROM is used for storing data or programs on a permanent basis.
Router	A linking device between network segments which may differ in Layers 1, 2a and 2b of the ISO/OSI Reference Model.
RS	Recommended Standard, for example, RS-232C. More recent designations use EIA, for example, EIA-232C.
RS-232C	Interface between DTE and DCE, employing serial binary data exchange. Typical maximum specifications are 50 feet (15m) at 19200 baud.
RS-422	Interface between DTE and DCE, employing the electrical characteristics of balanced voltage interface circuits.
RS-423	Interface between DTE and DCE, employing the electrical characteristics of unbalanced voltage digital interface circuits.
RS-449	General purpose 37-pin and 9-pin interface for DCE and DTE employing serial binary interchange.
RS-485	The recommended standard of the EIA that specifies the electrical characteristics of drivers and receivers for use in balanced digital multipoint systems.
RTU	Remote Terminal Unit. Terminal Unit situated remotely from the main control system.
S-Video	The luminance and chrominance elements of a video signal are isolated from each other, resulting in a far cleaner image with greater resolution.
SAA	Standards Association of Australia.
SAP	Service Access Point.
SDLC	Synchronous Data Link Control. IBM standard protocol superseding the bisynchronous standard.
Selectivity	A measure of the performance of a circuit in distinguishing the desired signal from those at other frequencies.
Self-calibrating	A self-calibrating board has an extremely stable on-board reference which is used to calibrate A/D and D/A circuits for higher accuracy.
Self-diagnostics	On-board diagnostic routine which tests most, if not all, of a board's functions at power-up or on request.
Serial Transmission	The most common transmission mode in which information bits are sent sequentially on a single data channel.
Session Layer	Layer 5 of the ISO/OSI Reference Model, concerned with the establishment of a logical connection between two application entities and with controlling the dialogue (message exchange) between them.

Shielding	The process of protecting an instrument or cable from external noise (or sometimes protecting the surrounding environment of the cable from signals within the cable.)
Short Haul Modem	A signal converter which conditions a digital signal to ensure reliable transmission over DC continuous private line metallic circuits, without interfering with adjacent pairs of wires in the same telephone cables.
Shutter	A mechanical or electronic device used to control the amount of time a light-sensitive material is exposed to radiation.
SI	International metric system of units (Système Internationale).
Sidebands	The frequency components which are generated when a carrier is frequency-modulated.
Upconverter	A device used to translate a modulated signal to a higher band of frequencies.
Sidereal Day	The period of an earth's rotation with respect to the stars.
Signal to Noise Ratio	The ratio of signal strength to the level of noise.
Signal Conditioning	Pre-processing of a signal to bring it up to an acceptable quality level for further processing by a more general purpose analog input system.
Simplex Transmission	Data transmission in one direction only.
Simultaneous Sampling	The ability to acquire and store multiple signals at exactly the same moment. Sample-to-sample inaccuracy is typically measured in nanoseconds.
Single-ended	See number of channels.
Slew Rate	This is defined as the rate at which the voltage changes from one value to another.
Smart Sensors	A transducer (or sensor) with an on-board microprocessor to pre-process input signals to the transducer. It also has the capability of communicating digitally back to a central control station.
SNA	Systems Network Architecture.
SNR	Signal to Noise Ratio.
Software Drivers	Typically a set of programs or subroutines allowing the user to control basic board functions, such as setup and data acquisition. These can be incorporated into user-written programs to create a simple but functional DAS system. Many boards come with drivers supplied.
Software Trigger	Software control of data acquisition triggering. Most boards are designed for software control.
SOH	Start of Header (ASCII Control-A).

Space	Absence of signal. This is equivalent to a binary zero.
Spark Test	A test designed to locate imperfections (usually pin-holes) in the insulation of a wire or cable by application of a voltage for a very short period of time while the wire is being drawn through the electrode field.
Spatial Resolution	A measure of the level of detail a vision system can display. The value, expressed in mils or inches per pixel, is derived by dividing the linear dimensions of the field of view (x and y, as measured in the image plane), by the number of pixels in the x and y dimensions of the system's imaging array or image digitizer.
Spatial Filtering	In image processing, the enhancement of an image by increasing or decreasing its spatial frequencies.
Spectral Purity	The relative quality of a signal measured by the absence of harmonics, spurious signals and noise.
Speed/Typical Throughput	The maximum rate at which the board can sample and convert incoming samples. The typical throughput is divided by the number of channels being sampled to arrive at the samples/second on each channel. To avoid false readings, the samples per second on each channel need to be greater than twice the frequency of the analog signal being measured.
Standing Wave Ratio	The ratio of the maximum to minimum voltage (or current) on a transmission line at least a quarter-wavelength long. (VSWR refers to voltage standing wave ratio)
Star	A type of network topology in which there is a central node that performs all switching (and hence routing) functions.
Statistical Multiplexer	Multiplexer in which data loading from multiple devices occurs randomly throughout time, in contrast to standard multiplexers where data loading occurs at regular predictable intervals.
STP	Shielded Twisted Pair.
Straight Through Pinning	EIA-232 and EIA-422 configuration that match DTE to DCE, pin for pin (pin 1 with pin 1, pin 2 with pin 2, etc).
Strobe	A handshaking line used to signal to a receiving device that there is data to be read.
STX	Start of Text (ASCII Control-B).
Subharmonic	A frequency that is a integral submultiple of a reference frequency.
Switched Line	A communication link for which the physical path may vary with each use, such as the public telephone network.
Sync	A synchronisation, or sync, pulse ensures that the monitor displaying the information is synchronized at regular intervals with

	<p>the device supplying the data, thus displaying the data at the right location.</p> <p>For example, a sync pulse would be used between a camera and a display device to reset the image to the top of the frame for the beginning of the image.</p>	
Synchronisation	The co-ordination of the activities of several circuit elements.	
Synchronous Transmission	Transmission in which data bits are sent at a fixed rate, with the transmitter and receiver synchronized. Synchronized transmission eliminates the need for start and stop bits.	
Talker	A device on the GPIB bus that simply sends information onto the bus without actually controlling the bus.	
Tank	A circuit comprising inductance and capacitance which can store electrical energy over a finite band of frequencies.	
TCP/IP	Transmission Control Protocol/Internet Protocol. The collective term for the suite of layered protocols that ensures reliable data transmission in an internet (a network of packet switching networks functioning as a single large network).	Originally developed by the US Department of Defense in an effort to create a network that could withstand an enemy attack.
TDM	Time Division Multiplexer. A device that accepts multiple channels on a single transmission line by connecting terminals, one at a time, at regular intervals, interleaving bits (bit TDM) or characters (Character TDM) from each terminal.	
TDR	Time Domain Reflectometer. This testing device sends pulses down the cable and enables the user to determine cable quality (distance to defect and type of defect) by the reflections received back.	
Temperature Rating	The maximum, and minimum temperature at which an insulating material may be used in continuous operation without loss of its basic properties.	
Text Mode	Signals from the hardware to the display device are only interpreted as text characters.	
Thresholding	The process of defining a specific intensity level for determining which of two values will be assigned to each pixel in binary processing. If the pixel's brightness is above the threshold level, it will appear in white in the image; if it is below the threshold level, it will appear black.	
TIA	Telecommunications Industry Association.	
Time Division	The process of transmitting multiple signals over a single channel by multiplexing taking samples of each signal in a repetitive time sequenced fashion.	

Time Sharing	A method of computer operation that allows several interactive terminals to use one computer.
Time Domain	The display of electrical quantities versus time.
Token Ring	Collision free, deterministic bus access method as per IEEE 802.2 ring topology.
TOP	Technical Office Protocol. A user association in USA which is primarily concerned with open communications in offices.
Topology	Physical configuration of network nodes, e.g. bus, ring, star, tree.
Transceiver	A combination of transmitter and receiver.
Transducer	Any device that generates an electrical signal from real-world physical measurements. Examples are LVDTs, strain gauges, thermocouples and RTDs. A generic term for sensors and their supporting circuitry.
Transient	An abrupt change in voltage of short duration.
Transmission Line	One or more conductors used to convey electrical energy from one point to another.
Transport Layer	Layer 4 of the ISO/OSI Reference Model, concerned with providing a network independent reliable message interchange service to the application oriented layers (layers 5 through 7).
Trigger	A rising edge at an 8254 timer/counter's gate input.
Trunk	A single circuit between two points, both of which are switching centres or individual distribution points. A trunk usually handles many channels simultaneously.
Twisted Pair	A data transmission medium, consisting of two insulated copper wires twisted together. This improves its immunity to interference from nearby electrical sources that may corrupt the transmitted signal.
UART	Universal Asynchronous Receiver/Transmitter. An electronic circuit that translates the data format between a parallel representation, within a computer, and the serial method of transmitting data over a communications line.
UHF	Ultra High Frequency.
Unbalanced Circuit	A transmission line in which voltages on the two conductors are unequal with respect to ground e.g. a coaxial cable.
Unipolar Inputs	When set to accept a unipolar signal, the channel detects and converts only positive voltages. (Example: 0 to +10 V).
Unloaded Line	A line with no loaded coils that reduce line loss at audio frequencies.
Upconverter	A device used to translate a modulated signal to a higher band of frequencies.
Uplink	The path from an earth station to a satellite.

USRT	Universal Synchronous Receiver/Transmitter. See UART.
UTP	Unshielded Twisted Pair.
V.35	CCITT standard governing the transmission at 48 kbps over 60 to 108 kHz group band circuits.
VCO	Voltage controlled oscillator. Uses variable DC applied to tuning diodes to change their junction capacitances. This results in the output frequency being dependent on the input voltage.
Velocity of Propagation	The speed of an electrical signal down a length of cable compared to speed in free space expressed as a percentage.
VFD	Virtual Field Device. A software image of a field device describing the objects supplied by it eg measured data, events, status etc which can be accessed by another node on the network.
VGA	Video Graphics Array. This standard utilizes analog signals only (between 0 and 1 V) offering a resolution of 640 by 480 pixels, a palette of 256 colors out of 256000 colors and the ability to display 16 colors at the same time.
VHF	Very High Frequency.
Vidicon	A small television tube originally developed for closed-circuit television. It is about one inch (2.54 cm) in diameter and five inches (12.7 cm) long. Its controls are relatively simple and can be operated by unskilled personnel. The Vidicon is widely used in broadcast service.
Volatile Memory	A storage medium that loses all data when power is removed.
Voltage Rating	The highest voltage that may be continuously applied to a wire in conformance with standards of specifications.
VRAM	Volatile Random Access Memory. See RAM.
VSD	Variable Speed Drive.
VT	Virtual Terminal.
WAN	Wide Area Network.
Waveguide	A hollow conducting tube used to convey microwave energy.
Wedge Filter	An optical filter so constructed that the density increases progressively from one end to the other, or angularly around a circular disk.
Word	The standard number of bits that a processor or memory manipulates at one time. Typically, a word has 16 bits.
X.21	CCITT standard governing interface between DTE and DCE devices for synchronous operation on public data networks.
X.25 Pad	A device that permits communication between non X.25 devices and the devices in an X.25 network.

- X.25 CCITT standard governing interface between DTE and DCE device for terminals operating in the packet mode on public data networks.
- X.3/X.28/X.29 A set of internationally agreed standard protocols defined to allow a character oriented device, such as a visual display terminal, to be connected to a packet switched data network.
- X-ON/X-OFF Control characters used for flow control, instructing a terminal to start transmission (X-ON) and end transmission (X-OFF).

Appendix B

Units and Abbreviations

<i>Unit Symbol</i>	<i>Unit</i>	<i>Quantity</i>
m	metre	length
kg	kilogram	mass
s	second	time
A	ampere	electric current
K	kelvin	thermodynamic temp
cd	candela	luminous intensity

Table B.1
SI units

<i>Symbol</i>	<i>Prefix</i>	<i>Factor by which unit is multiplied</i>
T	tera	10^{12}
G	giga	10^9
M	mega	10^6
k	kilo	10^3
h	hecto	10^2
da	deca	10
d	deci	10^{-1}
c	centi	10^{-2}
m	milli	10^{-3}
μ	micro	10^{-6}
n	nano	10^{-9}
p	pico	10^{-12}

Table B.2
Decimal Prefixes

Quantity	Unit	Symbol	Equivalent
plane angle	radian	rad	-
force	newton	N	kg m/s ²
work, energy heat	joule	J	N m
power	watt	W	J/s
frequency	hertz	Hz	s ⁻¹
viscosity: kinematic	-	m ² /s	10 c St (Centistoke)
dynamic	-	Ns/m ² or Pa s	10 ³ cP (Centipoise)
pressure	-	Pa or N/m ²	pascal, Pa

Table B.3
Supplementary and Derived Units

Quantity	Electrical unit	Symbol	Derived unit
potential	volt	V	W/A
resistance	ohm	Ω	V/A
charge	coulomb	C	A s
capacitance	farad	F	A s/V
electric field strength	-	V/m	-
electric flux density	-	C/m ²	-

Table B.4
Supplementary and Derived Unit (electrical)

Quantity	Magnetic unit	Symbol	Derived unit
magnetic flux	weber	Wb	V s = Nm/A
inductance	henry	H	V s/A = Nm/A ²
magnetic field strength	-	A/m	-
magnetic flux density	tesla	T	Wb/m ² = (N)/(Am)

Table B.5
Supplementary and Derived Units (magnetic)

Name	Symbol	Equivalent
Avogadro's number	N	6.023×10^{26} /((kg mol)
Bohr magneton	B	9.27×10^{-24} A m 25 ²
Boltzmann's constant	k	1.380×10^{-23} J/k
Stefan-Boltzmann constant	d	5.67×10^{-8} W/(m ² K ⁴)
Characteristic impedance of free space	Z _o	$(\mu_o/E_o)^{1/2}=120\pi\Omega$
Electron volt	eV	1.602×10^{-19} J
Electron charge	e	1.602×10^{-19} C
Electronic rest mass	m _e	9.109×10^{-31} kg
Electronic charge to mass ratio	e/m _e	1.759×10^{11} C/kg
Faraday constant	F	9.65×10^7 C/(kg mol)
Permeability of free space	μ _o	$4\pi \times 10^{-7}$ H/m
Permittivity of free space	E _o	8.85×10^{-12} F/m
Planck's constant	h	6.626×10^{-34} J s
Proton mass	m _p	1.672×10^{-27} kg
Proton to electron mass ratio	m _p /m _e	1835.6
Standard gravitational acceleration	g	9.80665 m/s ² 9.80665 N/kg
Universal constant of gravitation	G	6.67×10^{-11} N m ² /kg ²
Universal gas constant	R _o	8.314 kJ/(kg mol K)
Velocity of light in vacuo	C	2.9979×10^8 m/s
Volume of 1 kg mol of ideal gas at 1 atm & 0°C	-	22.41 m ³
Temperature	°C	$5/9(^{\circ}\text{F} - 32)$
Temperature	K	$5/9(^{\circ}\text{F} + 459.67)$ $5/9^{\circ}\text{R}$ $^{\circ}\text{C} + 273.15$

Table B.6
Physical Constants

Appendix C

Commonly used Formulae

Symbols used in formulae

The symbols described in the following table are used in the formulae shown in the next section

<i>Symbol</i>	<i>Description</i>	<i>SI Unit</i>
a	Velocity of sound	ms ⁻¹
a	Acceleration	ms ⁻²
A	Area	m ²
c	Velocity of light	ms ⁻¹
C	Capacitance	F
D	Diameter	m
E	Young's modulus	Nm ⁻²
ΔE	Energy difference	J
f	Frequency	Hz
F	Force	N
H	Magnetising force magnetic field strength	Am ⁻¹
I	Current	A
I	Moment of inertia	kgm ²
k	Radius of gyration	m
kp	Pitch factor of winding	-
l	Length	m
l	Length of conductor	m
L	Inductance	H
m	Mass	kg
M	Momentum	kg.m.s ⁻¹
n	Speed of rotation	rpm
N	Number of turns	-
p	Number of pole pairs	-

Symbol	Description	SI Unit
Q	Volumetric flow rate	m^3s^{-1}
Q	Charge	C
R	Resistance	Ω
s	Fractional slip	-
t	Time	s
T	Time Factor	-
T	Torque	Nm
T	Temperature (absolute)	K
ΔT	Temperature difference	$^{\circ}\text{C}$
u	Velocity	ms^{-1}
v	Velocity	ms^{-1}
V	Voltage	V
V	Volume	m^3
x	Distance (variables as in dx)	m
Z	Number of armature conductors	-
Z	Impedance	Ω
a	Coefficient of volumetric expansion	$\text{Hm}/(\text{mK})$
a	Resistance coefficient	ΩK^{-1}
b	Coefficient of volumetric expansion	K^{-1}
ϵ_0	Permittivity of free space	Fm^{-1}
ϵ_0	Permittivity-relative	-
μ_0	Permeability of free space	Hm^{-1}
μ_r	Permeability-relative	-
ρ_0	Resistivity	Ωm^3
r	Density	kgm^3
s	Stefan-Boltzmann constant	$\text{Wm}^{-2}\text{K}^{-4}$
ϕ	Angle	radians
F	Magnetic flux, flux per pole	Wb
w	Angular Velocity	rad.s^{-1}
w_n	Natural frequency	rad.s^{-1}
w_0	Natural frequency	rad.s^{-1}
w_d	Damped natural frequency	rad.s^{-1}

Formulae

Ohm's Law (DC version)

$$V = IR$$

$$I = \frac{V}{R}$$

Ohm's Law (AC version)

$$\underline{V} = \underline{I} \cdot \underline{Z}$$

Kirchhoff's Law

$$\sum_{j=0}^N I_j = 0$$

Power

$$P_{dc} = VI = I^2 R = \frac{V^2}{R}$$

$$P_{ac} = \text{Re}(\underline{V} \cdot \underline{I}) = VI \cos \phi$$

Resistance

Resistors in series:

$$R = R_1 + R_2 + R_3 + \dots$$

Resistors in parallel:

$$R = \frac{1}{\frac{1}{R_1} + \frac{1}{R_2} + \frac{1}{R_3} \dots}$$

Inductance

$$V = -L \frac{dI}{dt}$$

$$I = -\int \frac{V}{L} dt$$

$$L = N^2 \mu_0 \mu_r \frac{a}{l}$$

for LR circuit decay, stored energy is calculated as follows:

$$Energy = \frac{1}{2} L I^2$$

Capacitance

$$Q = CV = \int idt$$

$$i = \frac{dQ}{dt} = C \frac{dV}{dt}$$

For n parallel plates:

$$C = \epsilon_o \epsilon_r (n-1) \frac{a}{d}$$

$$\epsilon_o = 8.85 \times 10^{-12} \text{ Fm}^{-1}$$

For RC circuit discharge:

$$i = -Ie^{-\frac{t}{RC}}$$

Stored energy:

$$i = \frac{1}{2} \epsilon_o \epsilon_r a \left(\frac{V}{x} \right)^2$$

For capacitors in series:

$$C_{total} = \frac{1}{\frac{1}{C_1} + \frac{1}{C_2} + \frac{1}{C_3} \dots}$$

For capacitors in parallel:

$$C_{total} = C_1 + C_2 + C_3 + \dots$$

Electrostatics

$$F = \frac{Q_1 Q_2}{4\pi\epsilon_0 r^2}$$

$$\underline{F} = e \cdot \underline{E} = -e\Delta V$$

$$\underline{D} = \epsilon_0 \epsilon_r \underline{E}$$

Electromagnetism

$$E = -N \frac{d\phi}{dt}$$

$$B = \mu_0 \frac{1}{2\pi r}$$

$$F = BI$$

$$F = \mu_0 I_1 I_2 \frac{1}{2\pi d}$$

$$\frac{dH}{dl} = \frac{I \sin \alpha}{4\pi x^2}$$

For a solenoid:

$$H = \frac{NI}{l}$$

Magnetism

$$H = \frac{B}{\mu_o \mu_r}$$

For a magnetic circuit:

$$B = \frac{\Phi}{a}$$

Stored energy density:

$$Energy = \frac{1}{2} HB = \frac{1}{2} \frac{B^2}{\mu_o}$$

AC Circuits

$$V_{\max} = \frac{1}{\sqrt{2}} V_{\text{peak}}$$

$$\text{abs}(Z) = \left\{ R^2 + \left(\omega L - \frac{1}{\omega C} \right)^2 \right\}^{1/2}$$

$$Z = R + j\omega L + \frac{1}{j\omega C}$$

$$\text{Cos } \phi = \frac{R}{Z}$$

At resonance the following relationship holds true:

$$\omega = \omega_o = \frac{1}{\sqrt{LC}}$$

The Q factor can be calculated as follows:

$$Q_{factor} = \omega_o \frac{L}{R}$$

Sound

Note that decibels are not units as such but a ratio of voltages, currents and power, for example:

$$dB = 10 \log_{10} \frac{P_1}{P_2}$$

where: P_1, P_2 are the power levels:

$$dB = 20 \log_{10} \frac{V_1}{V_2}$$

For differing input and output impedances the following formula is appropriate:

$$dB = 20 \text{Log}_{10} \frac{V_1}{V_2} + 10 \text{Log}_{10} \frac{Z_2}{Z_1}$$

Where V_1, V_2 are the voltages
 Z_1, Z_2 are the impedances.

Appendix D

Resistor Color Coding

Resistor values are calculated according to the following color coding:

<i>Color on resistor</i>	<i>Value allocation</i>
Black	0
Brown	1
Red	2
Orange	3
Yellow	4
Green	5
Blue	6
Violet/Purple	7
Grey	8
White	9

Table D.1

Common Band Colors

Resistors have the following two major groupings of color coding:

Tolerance Band Colours - 1%

- ±1% - Brown
- ±2% - Red
- ±5% - Gold
- ±10% - Silver
- ±20% - No Band (or Black)

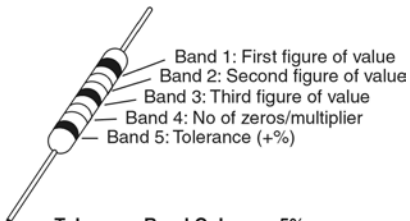

Tolerance Band Colours - 5%

- 2% - Red
- 5% - Gold
- 10% - Silver
- 20% - No Band

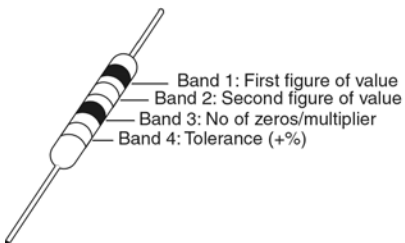

Figure D.1
Color coding for tolerance resistors